

FEATURES

- Field-Bus remote data acquisition
- RS-485 Master/Slave communication type
- MODBUS RTU/ASCII protocol
- 4 channel input
- Up to +/- 20mA input
- Watch-Dog Alarm
- Remotely Configurable
- 2000 Vac 3-way Galvanic Isolation
- High Accuracy
- EMC compliance – CE mark
- DIN rail suitable mounting - EN-50022 compliance

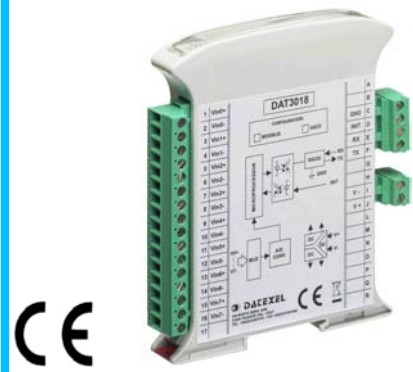

GENERAL DESCRIPTION

The DAT 3015 device is able to acquire up to 4 analog input signals. Data values are transmitted with MODBUS RTU/ASCII protocol on the RS-485 network (RS-232 interface is available).

It is possible to connect up to +/- 20mA current signals.

By means of a 16 bit converter, the device guarantee a high accuracy and a stable measure versus time and temperature.

To ensure the plant safety, two Watch-Dog timer alarms are provided.

The 2000 Vac isolation between input, power supply and serial line removes eventual ground-loop effects, allowing the use of the device even in the heavy environmental conditions.

DAT 3015 is in compliance with the 89/336/EEC directive on the electromagnetic compatibility.

The device is housed in a rough self-extinguishing plastic container which, thanks to its thin profile of 17.5mm only, allows a high density mounting on EN-50022 standard DIN rail.

COMMUNICATION PROTOCOLS

The DAT3015 is designed to work with the MODBUS RTU/ASCII protocol: standard protocol in field-bus; allows to directly interface DAT3000 series devices to the larger part of PLCs and SCADA applications available on the market.

For the protocol instructions, see the relative User Guide.

USER INSTRUCTIONS

Before to install the device, please read the "Installation Instruction" section.

If the module configuration is unknown, it can be hardly to establish a communication with them; connecting the INIT terminal to the GND terminal (ground), at the next power-up the device will be auto-configured in the default settings (see Operating User Guide).

Connect power supply, serial bus and analog inputs as shown in the "Wiring" section.

The "PWR" LED state depending to the working condition of the device: see the "Light Signalling" section to verify the device working state.

To perform configuration and calibration operations, read the instructions in the Operating User Guide.

To simplify handling or replacing of the device, it is possible to remove the wired terminals even with the device powered.

TECHNICAL SPECIFICATIONS (Typical @ 25 °C and in the nominal conditions)

Input type	Min	Max	Input Calibration (1)		Power Supply		
Current 20 mA	-20 mA	+20mA	+/- 20 uA		Supply Voltage	10 .. 30 Vdc	
			Linearity (1) mA +/-0,1%		Current consumption	30 mA @ 24 Vdc	
			Input Impedance mA <=50Ω		Polarity inversion protection	60 Vdc max	
			Thermal drift (1) Full Scale ± 0.005 % / °C		Isolation		
			Rise time 0.5 ÷ 2 sec.		Input – RS485	2000 Vac 50 Hz, 1 min.	
			Data Transmission		Supply – Input	2000 Vac 50 Hz, 1 min.	
			Baud Rate 38.4 Kbps		Supply – RS485	2000 Vac 50 Hz, 1 min.	
			Max distance 1.2 Km		Temperature & Humidity		
			Warm-up time 3 min.		Operating temperature	-10°C .. +60°C	
					Storage temperature	-40°C .. +85°C	
					Humidity (non condensing)	0 .. 90 %	
					Housing		
					Material	Self-extinguishing plastic	
					Mounting	EN-50022 DIN rail	
					Weight	~ 150 g.	
					EMC (for industrial environments)		
					Immunity	EN 61000-6-2	
					Emission	EN 61000-6-4	
			(1) Referred to input Span (difference between max. and min. values)				

INSTALLATION INSTRUCTIONS

The DAT 3015 device is suitable for fitting to DIN rails in the vertical position. For optimum operation and long life follow these instructions:

When the devices are installed side by side it may be necessary to separate them by at least 5 mm in the following case:

- If panel temperature exceeds 45°C and at least one of the overload conditions exist.

Make sure that sufficient air flow is provided for the device avoiding to place raceways or other objects which could obstruct the ventilation slits. Moreover it is suggested to avoid that devices are mounted above appliances generating heat; their ideal place should be in the lower part of the panel. Install the device in a place without vibrations.

Moreover it is suggested to avoid routing conductors near power signal cables (motors, induction ovens, inverters etc...) and to use shielded cable for connecting signals.

CABLING

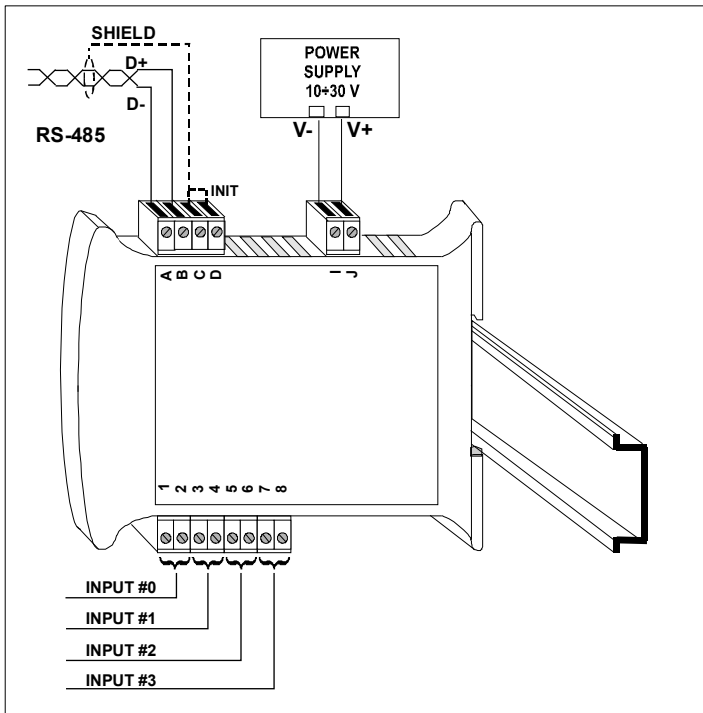

LIGHT SIGNALLING

LED	COLOUR	STATE	DESCRIPTION
PWR	GREEN	ON	Device powered
		OFF	Device not powered / Wrong RS-485 cabling.
		FAST BLINK	Communication in progress (blink frequency depends to baud-rate)
		1 second BLINK	Watch-Dog Alarm condition

MECHANICAL DIMENSIONS (mm)

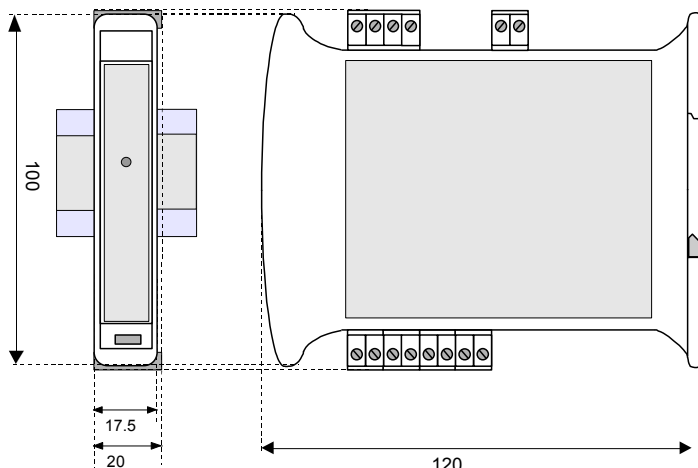

WIRING

ANALOG INPUT WIRING

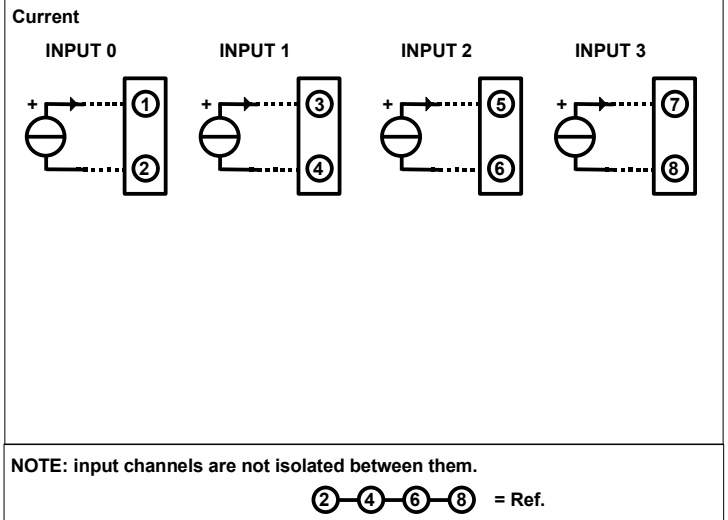

RS-485 NETWORK WIRING

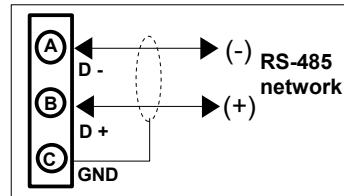

RS-232 NETWORK WIRING

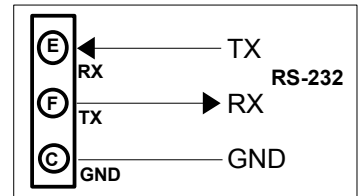

POWER SUPPLY WIRING

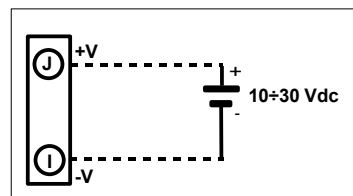

INIT WIRING

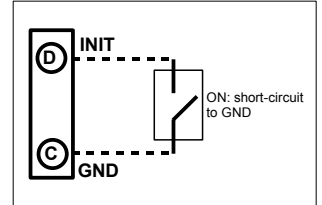

ISOLATION STRUCTURE

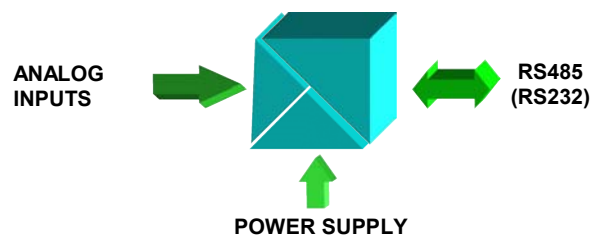

HOW TO ORDER

In the order phase, it is mandatory to specify the interface type (RS485 or RS232). DAT3015 can be supplied with the configuration specified by the customer. Please refer to the "Technical Specification" section for the output type available.

ORDER CODE:

DAT 3015-I / 485

Interface type
485 : RS-485
232 : RS-232

■ = Requested
□ = Optional